



COUGAR POWER

400W/550W/700W



TECHNICAL DETAILS & SPECIAL FEATURES

EFFICIENCY (80-plus Bronze certification)

Up to 88% of efficiency, compliant with 80-PLUS[®] Bronze efficiency requirement. Due to the extremely high efficiency of the COUGAR[®]-Series you can reduce your electricity costs in spite of high performance. In addition, less energy is converted into heat, which improves the cooling of the entire PC. Furthermore, the PSU fan can rotate more slowly, which reduces the noise-level of the whole system. In short, the PSU is efficient, cool and silent! You can find further information on the 80-plus certification on <http://www.80plus.org>.

DYNAMIC Dual-12V

Automatic dynamic load distribution on dual-12V line to provide power separately to the GPU and the CPU. If you are not using all output lines, the PSU automatically reroutes needed power from unused lines. This improves the performance of the 12V lines considerably for systems with high-end graphics cards in SLI[®] or CrossFire[®] mode. and provide high voltage stability to keep components safe.

HIGHEST DURABLE & RELIABLE 105 °C CAPACITORS

The best solution for a High-End PSU by using Japanese 105°C capacitors, 105°C rated Japanese capacitors provide uncompromised performance and reliability, delivering 4 times the lifespan of conventional 85°C rated capacitors.

AI COOLING & ULTRA-QUIET CONTROL SYSTEM

All PSUs of the COUGAR[®] POWER-Series are equipped with a large and very quiet 120mm fan, which adapts its rotating speed to the PSU temperature. Even on its highest rotating level the fan is still quiet enough to be barely noticeable.

MAINBOARD CONNECTOR

Because of the variable ATX main connector the COUGAR[®]-Series is compatible to the older ATX-standards as well. COUGAR[®] PSUs with 700 W or more also support E-ATX server mainboards with an additional 8 pin EPS 12V connector. All other PSUs have a 4+4 pin plug and can be used as 4 pin or as 8 pin solution.

COMPATIBLE WITH THE LATEST PC TECHNOLOGIES

Supports the newest specifications of ATX12V & EPS12V
Created for usage with current and next-generation multi-core CPU and GPU platforms.



TECHNICAL DETAILS & SPECIAL FEATURES

MULTI-CORE CPU & GPU READY

PSUs of the COUGAR® POWER-Series correspond to the most current ATX-standards.

Multi-core CPU and GPU systems are fully supported. Equipped with 6 pin / 8 pin PCI-Express plugs which are supplied through separate +12V lines, the COUGAR® POWER-Series PSUs especially excels in the stable supply of multi-GPU systems.

MULTI-GPU COMPATIBLE

NVIDIA SLI™ and ATI CrossFireX™ certified.

ENERGY STAR®

The PSUs of the COUGAR®-Series support the newest Energy Star standard. Thus COUGAR®-PSUs can be used for Energy Star® compatible systems.

ENVIRONMENT

The PSUs of the COUGAR®-Series adhere to the current guidelines 2002/95/EC (RoHS and WEEE) of the European Union. They contain no environmental pollutants; thus we as manufacturers and you as a customer support environmental protection.

EMC SOLUTION

Electro Magnetic Compatibility: Electromagnetic filtering protects the system against radiation

FULL PROTECTIONS WITH OCP, SCP, OVP, UVP, OPP.

80 Plus BRONZE CERTIFICATION

Due to the extremely high efficiency of the COUGAR®-Series you can reduce your electricity costs in spite of high performance.



COUGAR POWER
400/550/700

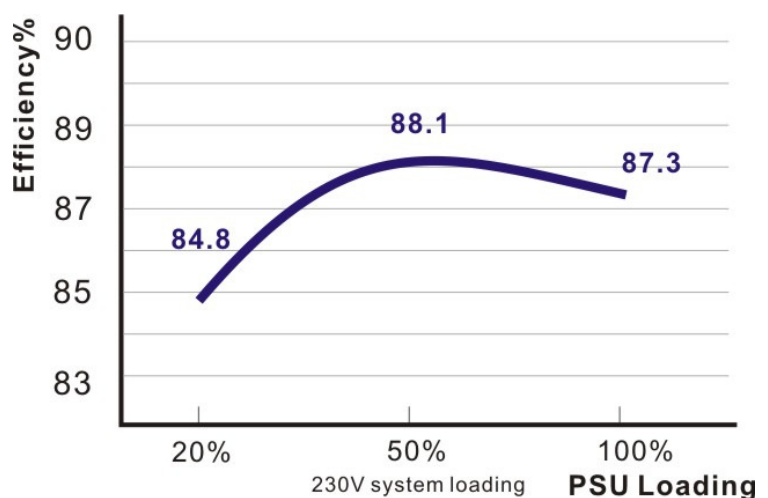



SPECIFICATION

ULTRA-QUIET & TEMPERATURE-CONTROLLED FAN

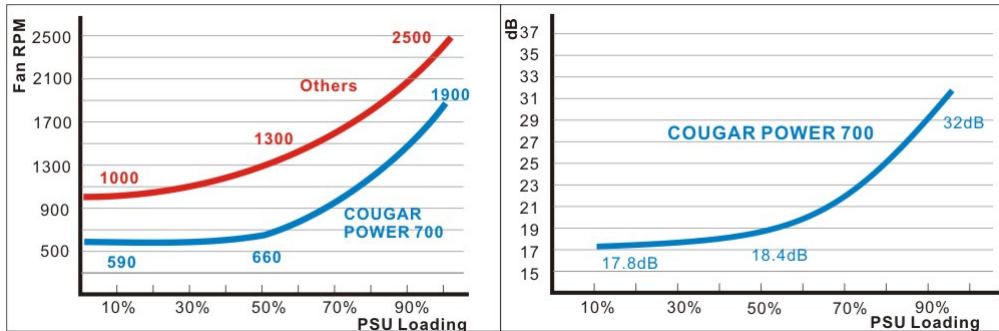

All PSUs of the COUGAR® POWER-Series are equipped with a large and very quiet 120mm fan(super low voltage & super low RPM), which adapts its rotating speed to the PSU temperature. Even on its highest rotating level the fan is still quiet enough to be barely noticeable.

DYNAMIC MULTI-12V



COUGAR POWER 400/550/700

Each different output voltage of the COUGAR®-PSU has its own internal switching and is protected against overloading and underloading through multiple safeguards.

All PSUs of the COUGAR®-PSU have an automatic dynamic load distribution on the 12V line. If you are not using all output lines, the PSU automatically reroutes needed power from unused lines. This improves the performance of the 12V lines considerably for systems with high-end graphics cards in SLI® or CrossFire® mode.

MODEL	+12V Output	12V1	12V2
COUGAR POWER 400	Support PC Devices	MB + Graphic card + Peripherals	CPU
	Connectors	24(20+4)Pins, Peripherals, Floppy PCI-E 6Pins, S-ATA	ATX 12V 4Pins, EPS 12V 8Pins
COUGAR POWER 550	Support PC Devices	MB+CPUx1/2 + Graphic cardx1 + Peripherals	CPUx1/2 + Graphic cardx1
	Connectors	ATX/EPS 12V 4Pins, PCI-E 8(6+2)Pins 24(20+4)Pins, Peripherals Floppy, S-ATA	ATX/EPS 12V 4Pins, PCI-E 6Pins
COUGAR POWER 700	Support PC Devices	MB+CPUx1/2 + Graphic cardx1 + Peripherals+ Fan cables	CPUx1/2 + Graphic cardx1
	Connectors	EPS 12V (4/8 Pins) PCI-E (6 Pins) 24(20+4)Pins, Peripherals Floppy, S-ATA, 3Pins	ATX 12V (4Pins)+EPS 12V (4/8 Pins) PCI-E (6 Pins+8(6+2)Pins)



TECHNICAL DETAILS & SPECIAL FEATURES

HIGHEST DURABLE & RELIABLE JAPANESE 105 °C CAPACITORS

COUGAR use the highest durable 105°C Japanese capacitors provide uncompromised performance and reliability, delivering 4 times the lifespan of conventional 85°C rated capacitors.

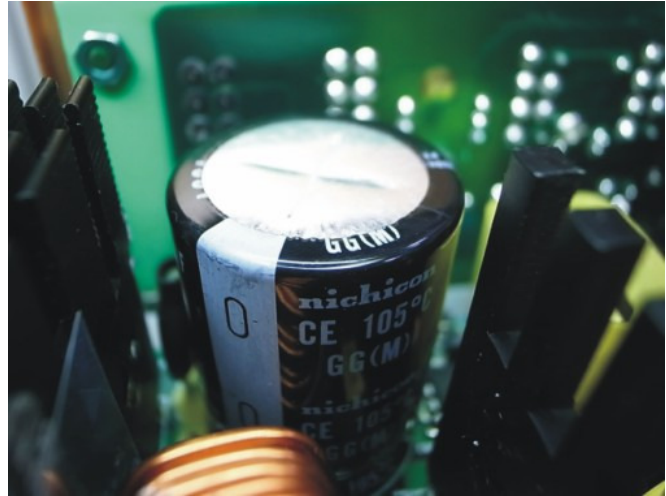

FULL SAFETY PROTECTION

Industrial-leading protection circuitry of OCP, SCP, OVP, UVP, OPP, protect your system all the time.

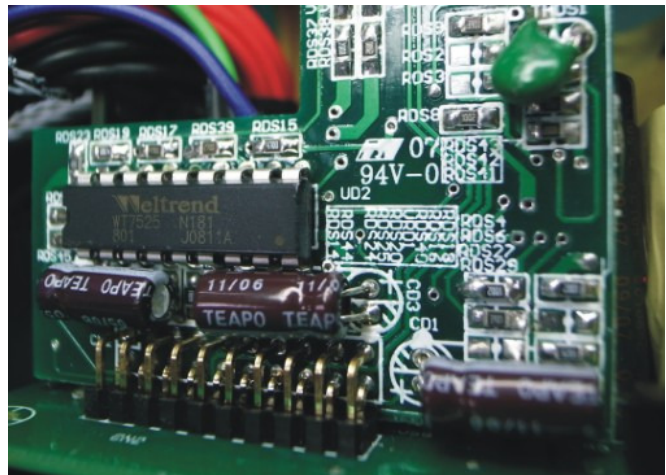

SPECIFICATION

RATING

Model Name	AC Input	DC Output						Total output	80 Plus®
		+3.3V	+5V	+12V1	+12V2	-12V	+5Vsb		
COUGAR 400	AC 100-240V 50-60Hz 8A	24A	15A	20A	20A	0.3A	3A max	400W	<input type="checkbox"/>
		120W		384W					
COUGAR 550	AC 100-240V 50-60Hz 10A	24A	15A	28A	20A	0.3A	3A max	550W	<input type="checkbox"/>
		120W		480W					
COUGAR 700	AC 100-240V 50-60Hz 10A	24A	20A	30A	30A	0.3A	3A max	700W	<input type="checkbox"/>
		150W		648W					



SPECIFICATION

CABLES & CONNECTORS

Item Name / Connector								
	Main Conn.	Molex Conn.	Floppy Conn.	ATX/EPS 12V Conn.	ATX/EPS 12V Conn.	S-ATA Conn.	PCI-E Conn.	PCI-E Conn.
Pin	24(20+4)	4pins	4pins	8pins	8(4+4)p	5pins	6pins	8(6+2)p
Cougar 400	1	5	1	-	1	4	2	-
Cougar 550	1	5	1	-	1	4	1	1
Cougar 700	1	5	1	1	1	5	2	2

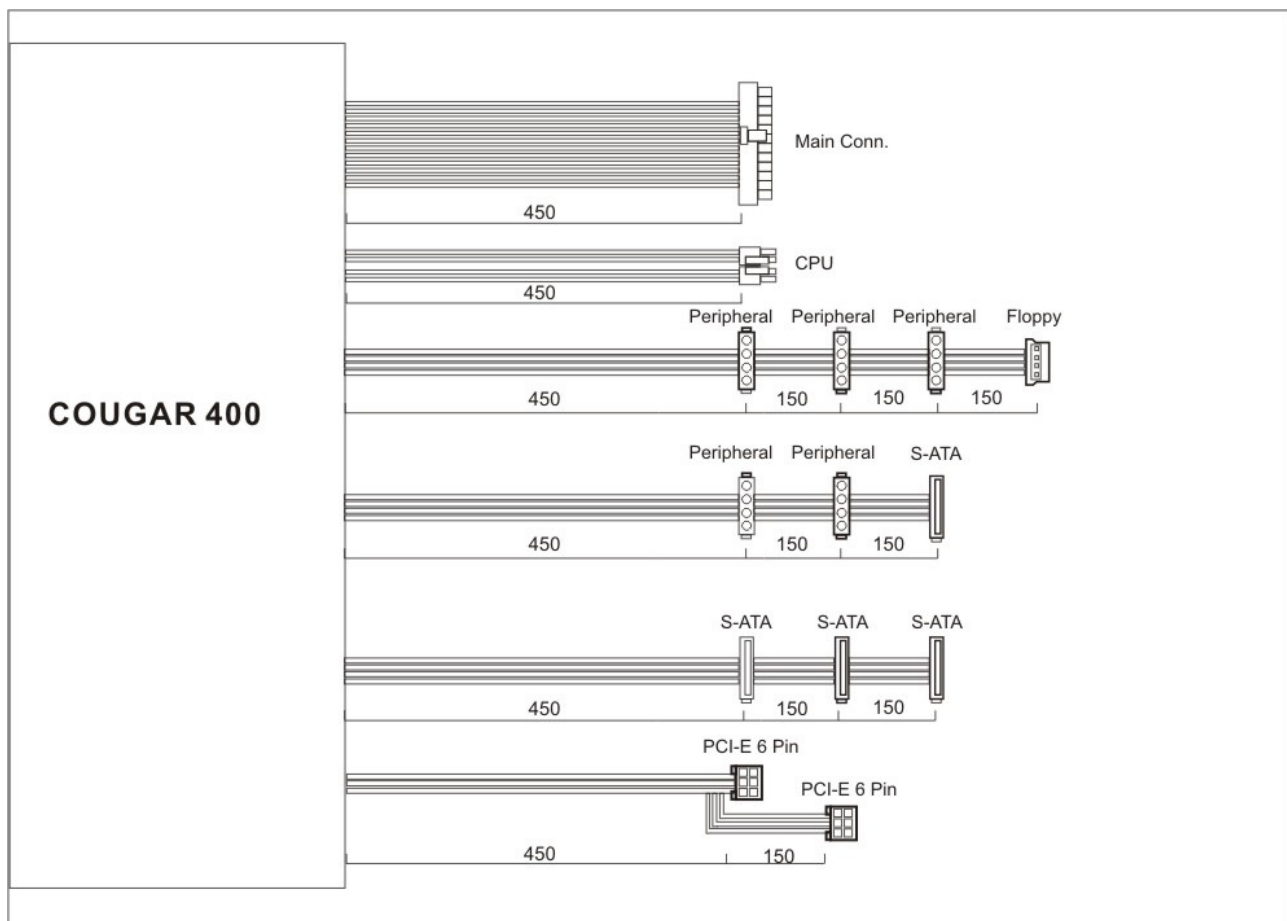



SPECIFICATION

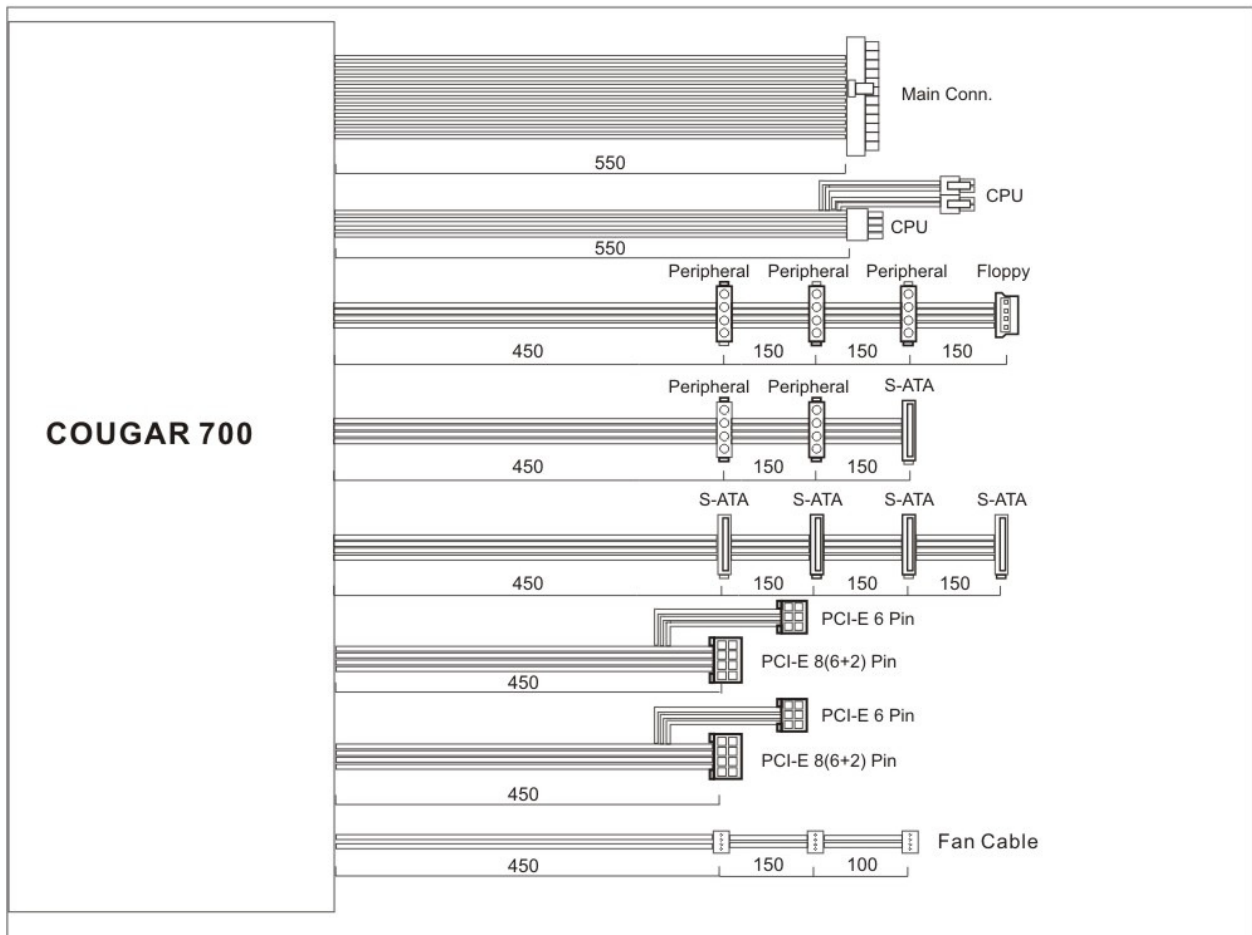
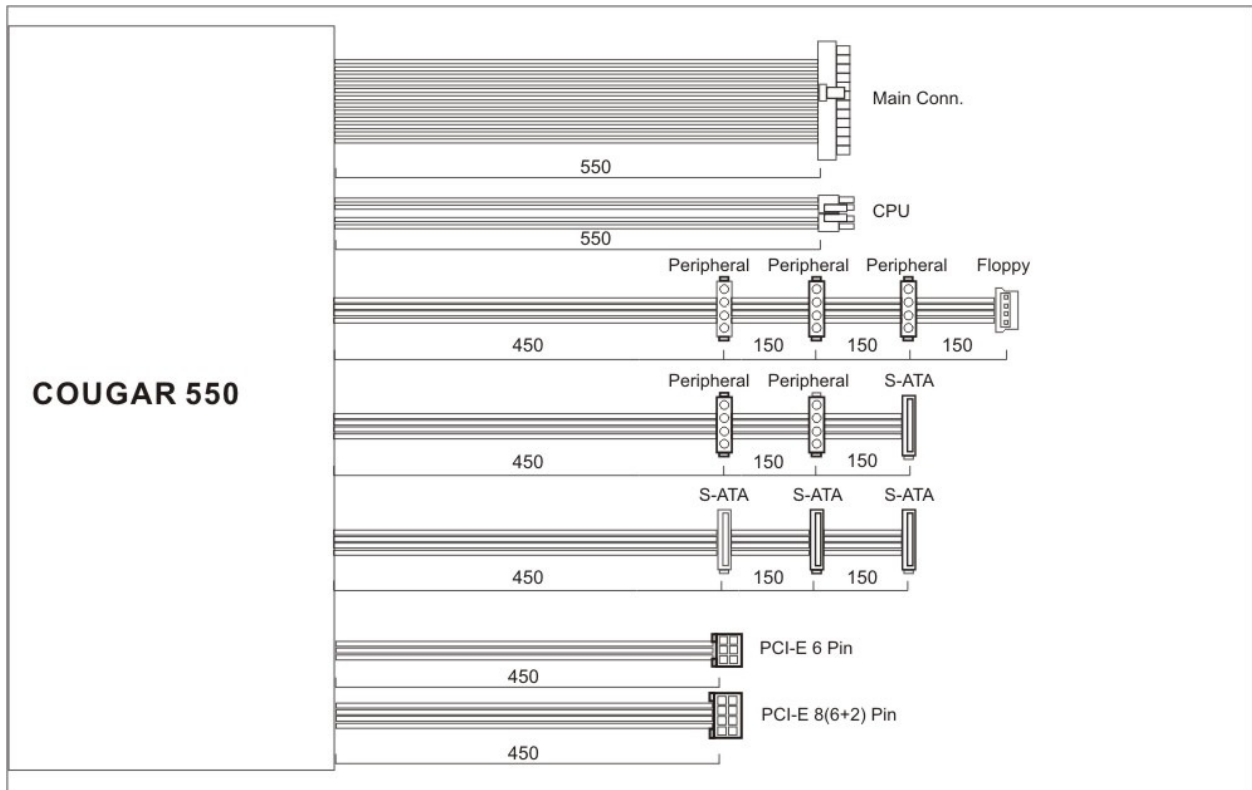



SPECIFICATION

DIMENSIONS

Dimension (L*W*H) mm	140 x 150 x 86
----------------------	----------------

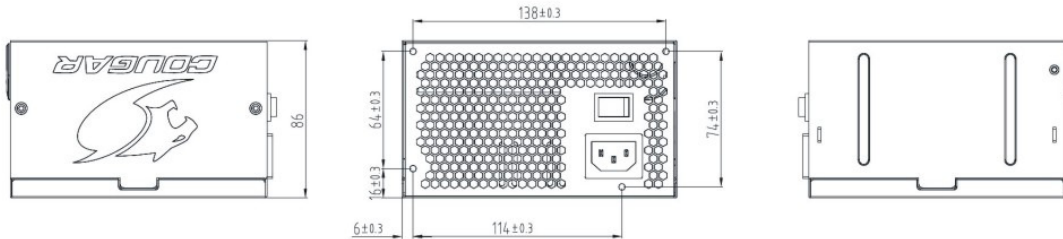
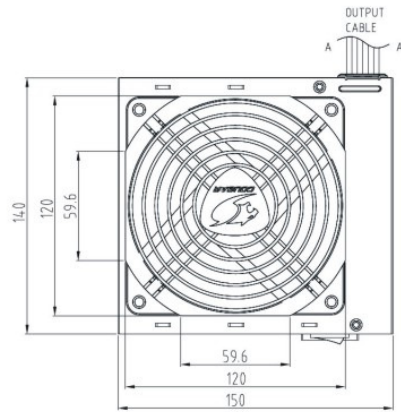
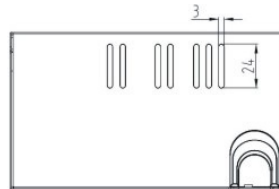



SPECIFICATION

SAFETY FUNCTIONS

UVP (Undervoltage protection)

If the voltages fall below a certain tolerance value on the single lines, the PSU automatically switches off.

OVP (Overvoltage protection)

If the voltages increase above a certain tolerance value on the single lines, the PSU automatically switches off.

SCP (Short-circuit protection)

In the case of a short-circuit this feature prevents damage to the core components of the PSU and its system components.

OPP (Overload protection)

If the system is oversized and requires more power from the PSU than it can perform, this protection function is activated.

OCP (Overcurrent protection)

If the load on a single line is higher than indicated, the PSU automatically switches off.

SAFETY & EMI CERTIFIED:

